



简介 PROFILE

广东泛仕达农牧风机有限公司 Guangdong Fans-tech Agro Co., Ltd

广东泛仕达农牧风机有限公司由泛仕达机电股份有限公司和广东筠城控股股份有限公司共同出资成立。是一家集研发、制造、销售于一体，专注于集约化养殖通风设备的现代化企业。

公司位于云浮市新兴县新城工业园区内，占地面积约100亩，拥有多条自动化生产线，完善的试验与检测设备和健全的生产管理体系。公司是ISO9001国际质量体系认证企业，多项产品通过了CE、CCC等认证且具备美国BESS实验室测试报告。同时，公司注重技术投入，凭借其研发实力被认定为“国家高新技术企业”，并拥有多项发明和实用新型专利研发成果。

未来，公司将继续以“诚信、创新、共赢”为经营理念，密切结合市场需求，为全球客户提供个性化的通风解决方案及各类技术高端、制作精良的农牧通风产品。

Guangdong Fans-tech Agro Co., Ltd is a joint venture formed by Fans-tech Electric Co., Ltd and Guangdong Juncheng Investment Holding Co., Ltd. It is a modern enterprise integrating R&D, engineering, manufacturing and sales with an acute focus on intensive poultry and livestock breeding ventilation equipment.

Fans-tech Agro is located in Xincheng Industrial Park, Xinxing County, Yunfu City, covers an area of 67,000 square meters. We have established automated production lines, equipped with complete experiment and testing facility, and set a sound production and quality management system. Our company has been qualified as ISO9001 international quality management system, many products have passed the identification of CE and CCC, and testing data is verified by BESS laboratory. At the same time, Fans-tech values technical input and has been recognized as National High-Tech Enterprise by virtue of its research and development strength; and it has a number of national invention patents and utility model patents. and all kinds of high-end technology, well-made agricultural and animal husbandry ventilation products.

Looking into the future, Fans-tech Agro will continue to adhere to the philosophy of "integrity, innovation, win-win", and closely combine with market demands to provide global customers with personalized ventilation solutions and various ventilation products with high-end technology and cost-effectiveness.



目录

CONTENTS

1 01-03 公司介绍
COMPANY PROFILE

2 04-10 玻璃钢风机系列
FIBERGLASS FAN SERIES

3 11-16 镀锌板风机系列
GALVANIZED BOX FAN SERIES

4 17-21 循环风机系列
CIRCULATION FAN SERIES

5 22-24 屋顶风机系列
CHIMNEY FAN SERIES

6 25-29 圆筒风机系列
DRUM FAN SERIES

7 30-33 配件系列
ACCESSORIES

为什么选择泛仕达

Why Fans-tech Agro

技术领先

LEADING TECHNOLOGY

依托总部泛仕达机电20年来雄厚的工业风机技术基础和制造经验，公司拥有国家CNAS认证认可实验室和美国UL目击实验室。配备先进的噪音振动测试分析系统和美国AMCA标准风洞实验室，同时拥有力学、环境、寿命等多个专项测试实验室。

With 20 years' industrial fan technology and manufacturing experience, Fans-Tech founded the country's CNAS accredited laboratory and an American UL certified witness lab equipped with advanced noise, vibration and American AMCA standard wind tunnel test analysis stations. In addition, our R&D facilities include independent Mechanical, Environmental and Endurance Testing labs.

20

20年研发制造经验
20 years' development & manufacturing experience



资质实验室
Qualification laboratory

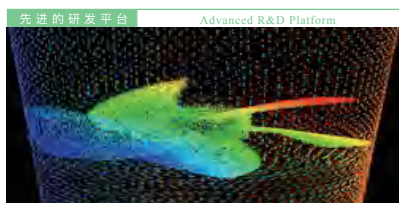

产品设计采用尖端的流体仿真分析及电磁仿真分析等开发软件，并与国内多所一流高等院校产学研合作，公司同时拥有一支由博士，硕士，高级工程师等各类专业人才组成的研发团队。

Advanced fluid simulation analysis and electromagnetic simulation analysis software are adopted in product design. By cooperating with many domestic first-class universities and colleges in education, research and production, Fans-tech Agro formed a high-level R&D team composed of doctors, masters, senior engineers and other professionals.

技术领先

LEADING TECHNOLOGY

泛仕达一直注重技术研发，目前已被认定为“国家高新技术企业”，并拥有多项国家发明专利和实用新型专利研发成果。

Fans-tech values technical input and has been recognized as National High-Tech Enterprise by virtue of its research and development strength; and our entire series features many unique and pioneering design patents.



高风量 & 高效率

High air flow & high efficiency

1 叶轮通过CFD仿真分析，实现工作点效率最高
Propellers are analyzed by CFD simulation to achieve the highest efficient working points.

2 全系列风机采用超高效电动机
Ultra-efficient Motors are used in the design of our full range of fans.

3 全系列风机的风量与能效，达到国际一流水准
Fans-Tech Agro fans feature industry bench mark standards in Air Volume and Energy Efficiency.

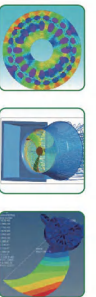
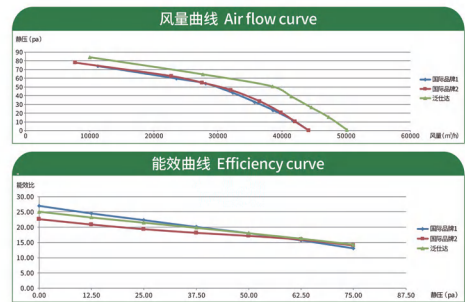

▶ 风量如一 | Air flow never decay

特殊设计的扇叶叶型与扎实的选材用料，风量终身不会衰减。

Special design, shape and material of the propeller insure proper air volume over the lifetime of the unit.

▶ 耐腐蚀性强 | Strong corrosion resistance

耐腐蚀性超强，能适应各种恶劣环境。

Super strong anti-corrosive ability offers worry-free use in the harshest of environments.

▶ 测试严苛 | Rigorous testing

产品通过2倍超速，200Hz高频振动，高低温交变，±20%电源电压波动测试，户外淋雨等严苛的可靠性测试。

All products have passed rigorous reliability tests to include 2 times over-speed test, 200Hz high frequency vibration test, high and low temperature alternation test, ± 20% voltage fluctuation test, and outdoor rain test.

高可靠性 High Reliability

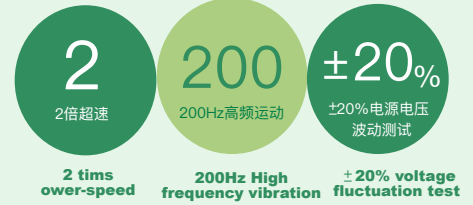

质量保证 Quality Guarantee



泛仕达产品在生产制作过程中，每道工序都经过严格的质量把控，其关键零部件-电机部分更是经过三道全检：绕组定子全检、电机全检、整机检测，确保每一台产品完美的到达客户的手中。泛仕达出厂的每一台风机都有独立的二维码，确保产品质量的可追溯性。同时，我们为客户提供整机三年的质量保证。

In the production process, each procedure has been strictly quality controlled, and as the key part of the fan, motor has passed three full inspections: winding inspection, motor inspection, and operation inspection. Which ensures the free-worry usage to customers. Each fan has its own QR code to ensure traceability of product quality. Besides, we provide three years warranty for full.

所有风叶100%动平衡
Propeller 100% dynamic balanced



100% 通过综合性能测试
100% Comprehensive performance tested



绕组全检
Winding inspection



电机全检
Motor inspection



玻璃钢风机系列

Fiberglass Fan Series





玻璃钢风机系列特点与优势

Features & Advantages

 **风量**
高强度机翼型压铸铝扇叶，采用流体仿真最优化设计叶型，确保养殖舍内充足的空气流通量。

 **噪音低**
流畅的叶型与高动平衡精度使运行中的叶片与空气摩擦系数小、共振小、确保低噪音，提升动物生存环境的舒适度。

 **免维护**
全系列均采用直联驱动，传动效率高，结构简单，免除定期更换皮带的麻烦，减少更换皮带的成本。

 **效率高**
采用超高效电机，IP55防水防尘保护，F级绝缘，效率高达85%，节能省电，节约养殖成本，提高养殖收益。

 **高防腐**
高强度玻璃钢壳体，钢质喷粉防护网罩，SUS304不锈钢材质紧固件与配附件，为风机提供卓越的耐腐蚀能力，坚固耐用。

 **个性化**
可选配变频或定速版，铝合金百叶窗或PVC百叶窗，满足不同养殖需求。

 **Large Air Flow**
Being optimized with fluid simulation design, the high-strength die-cast airfoil aluminum propeller provides large air flow to ensure adequate air circulation in the breeding house.

 **Low Noise**
The smooth propeller shape and high dynamic balance accuracy makes tiny friction coefficient between the blade and air combined with small resonance during running, which ensures low noise and improves the living comfort for the animals.

 **Maintenance Free**
Direct driving with high transmission efficiency and simple structure eliminates the trouble of regular belt replacement and reduces the using cost.

 **High Efficiency**
IP55 waterproof and dust-proof protection, F class insulation, ultra-efficient motor with 85% efficiency enables animal producers to save breeding costs and increase profits.

 **High Corrosion Resistance**
The high-strength fiberglass reinforced house, powder-sprayed steel protective mesh, combined with SUS304 stainless steel accessories provide excellent corrosion resistance and durability.

 **Customer-oriented Option**
Fixed speed version or variable frequency version, aluminium shutter or PVC shutter is optional to meet various needs.





AF系列 | AF SERIES

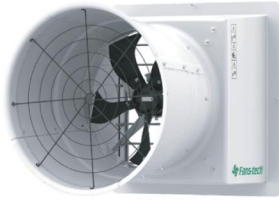

18寸、24寸五叶
18" & 24" with five blades



36寸、50寸三叶
36" & 50" with three blades



18寸、24寸可选配导流罩
diversion hood is optional for 18", 24"

18寸、24寸与36寸风机可根据需求选配变频版
Frequency conversion version is optional for 18", 24" and 36" fan

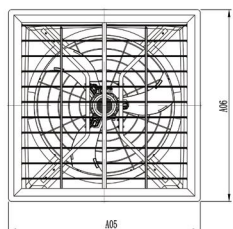
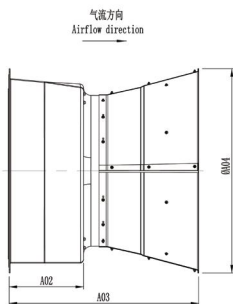
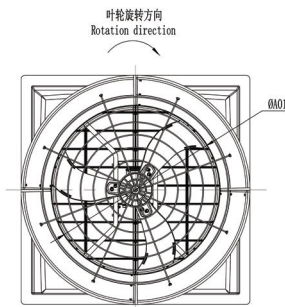

型号 Model No.		AF455B2-070-00	AF625B3-077-00	AF915B3-077-00	AF1270B5-106-00	
规格 Diameter of blade (inch)		18"	24"	36"	50"	
电机 Motor	电压 Voltage (V)	380	380	380	380	
	频率 Hertz (Hz)	50	50	50	50	
	相数 Phase	3	3	3	3	
	功率 Power (KW)	0.37	0.37	0.55	1.1	
	输入电流 Current @0Pa (A)	0.85	1.1	1.66	4.25	
性能参数 Performance	风量 Airflow (m ³ /hr.)	0pa	7400	13600	22100	47800
		-25pa	6900	12300	19700	42700
		-50pa	6300	10800	17300	36200
	能效比 Efficiency (CMH/Watt)	25.4	29.2	31.2	31	
特征 Features	驱动方式 Drive	直联驱动 Direct drive				
	风叶 Propeller	5片铝叶 5-Aluminum		3片铝叶 3-Aluminum		
外形尺寸 Dimension (mm)	A01	455	625	915	1270	
	A02	368	373	463.5	404	
	A03	892	987	1182	1313	
	A04	630	850	1270	1724	
	A05	715.5	903	1269	1555	
	A06	715.5	903	1269	1555	
	洞口尺寸 Dimension of opening (mm)	615×615	805×805	1150×1150	1440×1440	

EF系列 | EF SERIES



ADVANTAGES

- ▶ 泛仕达品牌智能无极变速EC电机，赋予风机全面的保护功能：如缺相、浪涌电压、过欠电压、堵转、过电流、温度保护等；
- ▶ 电动铝合金百叶窗，可在全部转速范围内实现全开，确保风机大风量和高效率运行；
- ▶ 支持485总线实现多台风机的集中运行控制(选配)；
- ▶ 采用0~10V / PWM控制信号；宽高效区间，确保风机低功耗运行。
- ▶ Fans-tech intelligent variable speed control of EC motor, endows the fan with full protections: such as phase failure, over-voltage, under-voltage, locked-rotor, over-current and temperature protection.
- ▶ Electric control aluminum alloy shutter, which can be fully opened in all speed range to ensure large air volume and high efficiency.
- ▶ Support centralized operation control of multiple fans (Optional).
- ▶ Variable speed can be achieved via 0 ~ 10V / PWM control signal, wide high-efficiency interval to ensure low power consumption.

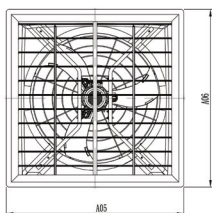
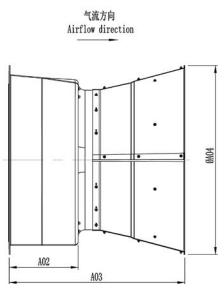
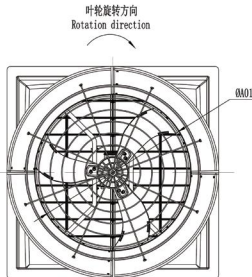

型号 Model No.		EF915D5-112-00	EF1270D5-155-00	
规格 Diameter of blade (inch)		36"	50"	
电机 Motor	电压 Voltage (V)	220	380	
	频率 Hertz (Hz)	50	50	
	相数 Phase	1	3	
	功率 Power (KW)	0.55	1.1	
	输入电流 Current @0Pa (A)	5.5	10.5	
性能参数 Performance	风量 Airflow (m ³ /hr.)	0pa	23580	52310
		-25pa	21430	46530
		-50pa	19120	40170
	能效比 Efficiency (CMH/Watt)	28.8	32.6	
特征 Features	驱动方式 Drive	直联驱动 Direct drive		
	风叶 Propeller	3片铝叶 3-Aluminum		
外形尺寸 Dimension (mm)	A01	915	1270	
	A02	463.5	404	
	A03	1182	1313	
	A04	1270	1724	
	A05	1269	1555	
	A06	1269	1555	
	洞口尺寸 Dimension of opening (mm)	1150×1150	1440×1440	



HPF系列 | HPF SERIES



ADVANTAGES

- ▶ 专为高负压养殖环境设计，可长期承载200Pa高负压平稳运行，是为楼房养殖模式提供通风支持的理想之选。
- ▶ 可选配风机专用电动卷闸门，确保风机使用时的通风顺畅及风机停机后的密闭性。
- ▶ Specially designed for high negative pressure breeding environment with long-term bearing capacity of -200Pa operation. It is an ideal choice to provide ventilation supporting for high-rise multistory breeding buildings.
- ▶ Electric rolling shutter is optional to equip to ensure smooth ventilation during operating and air-tightness after the fan is stopped.

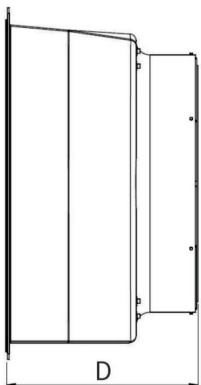
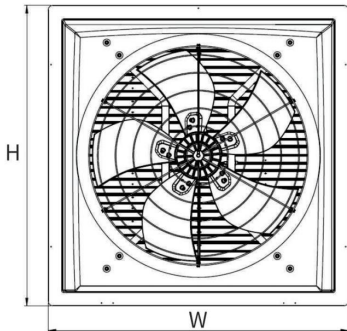

型号 Model No.		HPF710B2-081-00	HPF800B3-106-00	HPF900B3-106-00	
规格 Diameter of blade (inch)		28"	32"	36"	
电机 Motor	电压 Voltage (V)	380	380	380	
	频率 Hertz (Hz)	50	50	50	
	相数 Phase	3	3	3	
	功率 Power (KW)	1.1	1.5	2.2	
	输入电流 Current @0Pa (A)	3.5	4.2	6.5	
性能参数 Performance	风量 Airflow (m ³ /hr.)	0pa	16900	23500	31570
		-100pa	15000	19600	26830
		-150pa	13800	16600	23080
		-200pa	12200	/	17740
特征 Features	驱动方式 Drive	直联驱动 Direct drive			
	风叶 Propeller	5片铝叶 5-Aluminum			
外形尺寸 Dimension (mm)	宽×深×高 W×D×H	970×560×970	1270×580×1270	1270×580×1270	
	洞口尺寸 Dimension of opening (mm)	870×870	1150×1150	1150×1150	



MPF系列 | MPF SERIES



ADVANTAGES

- ▶ 可广泛应用于各种养殖环境，特别是满足-75pa到-120pa负压范围的应用，是为装配滤网和除臭系统的养殖舍和楼房养殖等养殖模式提供通风支持的理想之选。
- ▶ Adapt to various farm building, especially for the application ranging from -75Pa to -120Pa. It is an ideal choice to provide ventilation supporting for breeding houses equipped with filters or deodorizing systems and high-rise multistory breeding buildings.

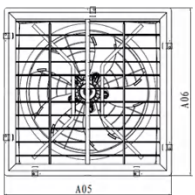
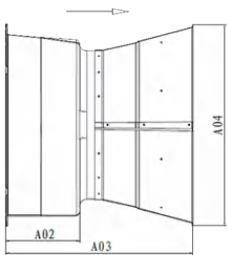
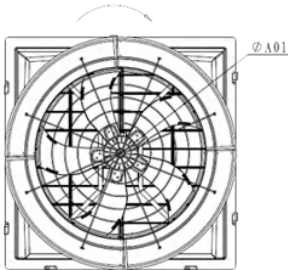

型号 Model No.		MPF625B2-077-00	MPF915B3-077-00	MPF1300B4-106-00	MPF1450B4-120-00	
规格 Diameter of blade (inch)		24"	36"	51"	57"	
电机 Motor	电压 Voltage (V)	380	380	380	380	
	频率 Hertz (Hz)	50	50	50	50	
	相数 Phase	3	3	3	3	
	功率 Power (KW)	0.75	0.75	1.80	2.20	
	输入电流 Current @0Pa (A)	2.2	2.6	4.6	6.7	
性能参数 Performance	风量 Airflow (m ³ /hr.)	-50pa	15050	19700	44500	56200
		-75pa	14060	17700	39500	52000
		-100pa	12960	15100	34000	45200
特征 Features	驱动方式 Drive		直联驱动 Direct drive			
	风叶 Propeller	5片铝叶 5-Aluminum		4片铝叶 4-Aluminum	5片铝叶 5-Aluminum	
外形尺寸 Dimension (mm)	A01	625	915	1290	1450	
	A02	373	463.5	390	430	
	A03	987	1182	1367	1640	
	A04	850	1270	1595	1860	
	A05	903	1270	1594	1742	
	A06	903	1270	1594	1742	
	洞口尺寸 Dimension of opening (mm)	805×805	1150×1150	1510×1510	1670×1670	



SF系列 | SF SERIES



叶轮旋转方向
Rotation direction

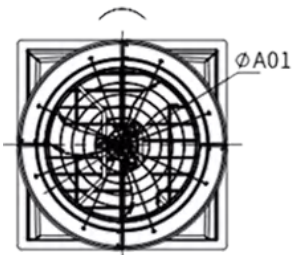

气流方向
Airflow direction

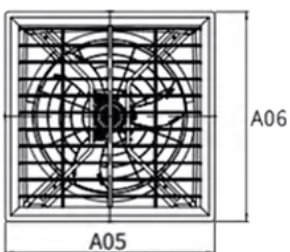
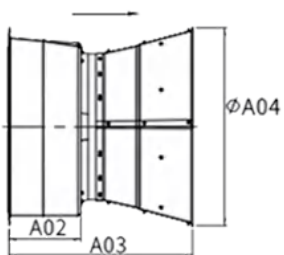

型号 Model No.		SF455B2-070-00	SF625B3-077-00	SF915B3-077-00	SF1270B5-106-00	
规格 Diameter of blade (inch)		18"	24"	36"	50"	
电机 Motor	电压 Voltage (V)	380	380	380	380	
	频率 Hertz (Hz)	50	50	50	50	
	相数 Phase	3	3	3	3	
	功率 Power (KW)	0.25	0.37	0.55	1.1	
输入电流 Current @0Pa (A)		0.8	1.14	1.7	4.1	
性能参数 Performance	风量 Airflow (m ³ /hr.)	0pa	6960	12530	21400	45000
		-25pa	6390	11440	19200	40000
		-50pa	5710	9920	16700	34000
	能效比 Efficiency (CMH/Watt)	23.4	24.4	27.3	29.3	
特征 Features	驱动方式 Drive	直联驱动 Direct drive				
	风叶 Propeller	5片铝叶 5-Aluminum		3片铝叶 3-Aluminum		
外形尺寸 Dimension (mm)	A01	455	625	915	1270	
	A02	368	373	463.5	404	
	A03	892	987	1182	1313	
	A04	630	850	1270	1724	
	A05	715.5	903	1269	1555	
	A06	715.5	903	1269	1555	
洞口尺寸 Dimension of opening (mm)		615×615	805×805	1150×1150	1440×1440	





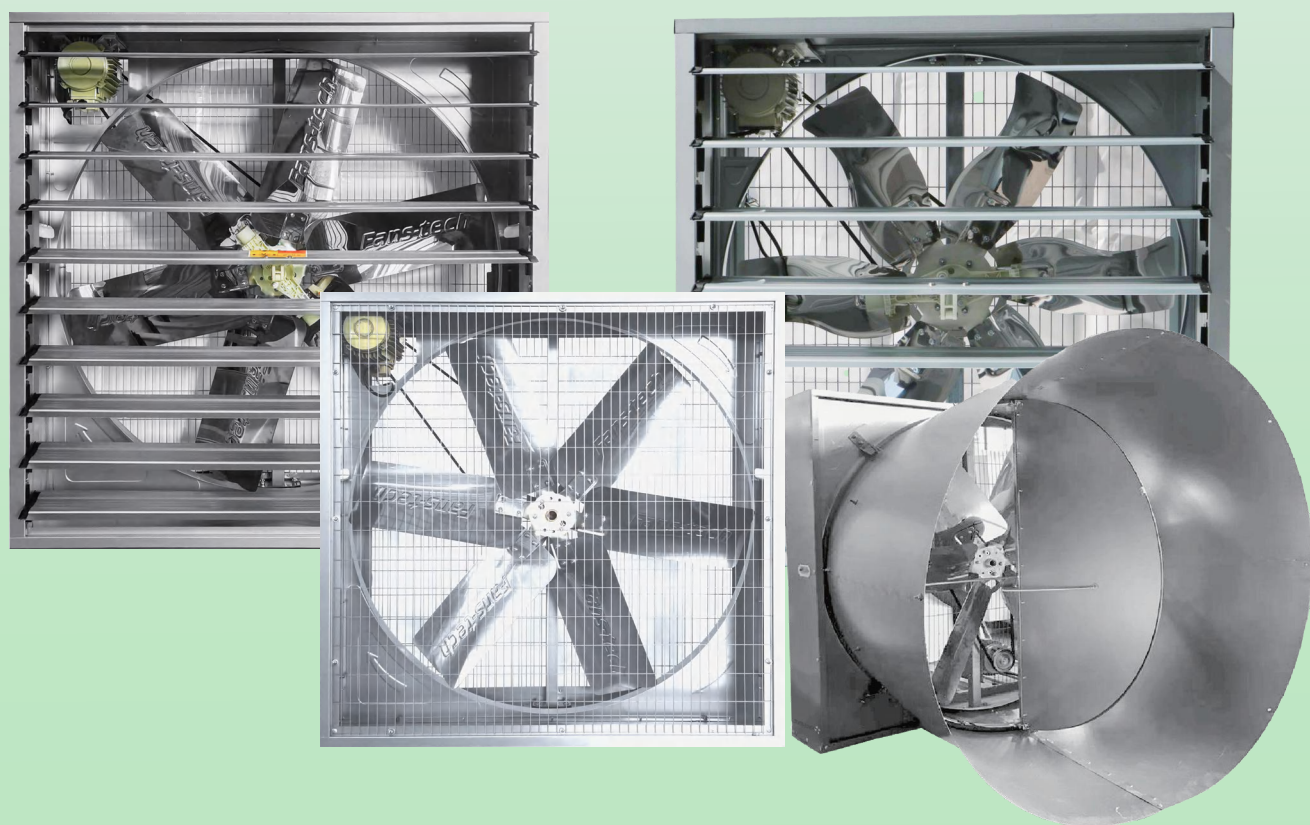

镀锌板风机系列







Galvanized Box Fan Series



镀锌板风机系列特点与优势

Features & Advantages

- 
风量大
 自主知识产权流体设计，高强度不锈钢扇叶，确保低噪音、高效率和大风量。
- 
效率高
 采用超高效电机，IP55防水防尘保护，F级绝缘，效率高达85%，节能省电，节约养殖成本，提高养殖收益。
- 
高强度
 “X”型加强筋镀锌板壳体，275g/m²镀锌层，能承受严苛的养殖场所腐蚀性环境考验。
- 
寿命长
 皮带传动，采用进口皮带，耐磨耐用。
- 
密闭性佳
 百叶由离心式推拉器控制，自动开合，闭合紧密不透光、不漏风。
- 
应用广
 可广泛应用于各种畜禽养殖，温室大棚，各类仓库以及厂房降温。

- 
Large Air Flow
 High-strength stainless steel propeller with advanced fluid design that provides large air flow, low noise, and high efficiency.
- 
High Efficiency
 IP55 waterproof and dust-proof protection, F class insulation, ultra-efficient motor with 85% efficiency enables animal producers to save breeding costs and increase profits.
- 
High Strength
 Box housing and venturi nozzle are made of “X” gauge galvanized sheet-steel with 275g/m² zinc layer coating, which enables to withstand the harsh environment of the breeding sites.
- 
Long Durability
 Belt drive, adopt imported famous brand belt, made of neoprene composite materials and fiberglass cord core, that provides high strength, good wear resistance, high flexibility and high tensile resistance.
- 
Excellent Air-tightness
 The shutter is automatically open and close by a centrifugal push-pull device, which ensures air tightness and prevents light transmittance.
- 
Wide Application
 An ideal choice for ventilation and cooling in animal breeding houses, greenhouses, various warehouses, workshops and more.





BT系列 | BT SERIES

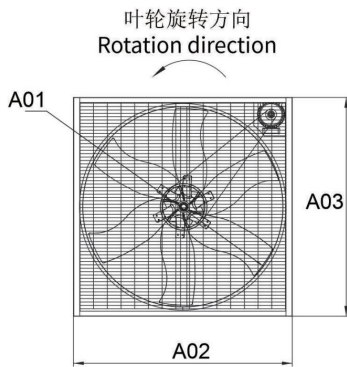

气流方向
Airflow direction

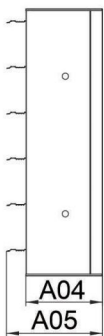

型号 Model No.		BT915B2-077-00		BT1270B2-081-00	
规格 Diameter of blade (inch)		36"		50"	
电机 Motor	电压 Voltage (V)	380	230	380	230
	频率 Hertz (Hz)	50	60	50	60
	相数 Phase	3		3	
	功率 Power (KW)	0.55		1.1	
输入电流 Current @0Pa (A)		1.7		3	
性能参数 Performance	风量 Airflow (m ³ /hr.)	0pa	19100	40000	
		-25pa	16400	36000	
		-50pa	13300	30700	
能效比 Efficiency (CMH/Watt)		23.3		25	
特征 Features	驱动方式 Drive	皮带传动 Belt driven			
	风叶 Propeller	6片铝叶 6-Aluminum			
外形尺寸 Dimension (mm)	A01	915		1270	
	A02	1000		1380	
	A03	1000		1380	
	A04	450		450	
	A05	500		500	
洞口尺寸 Dimension of opening (mm)		1020×1020		1440×1440	



QT系列 | QT SERIES

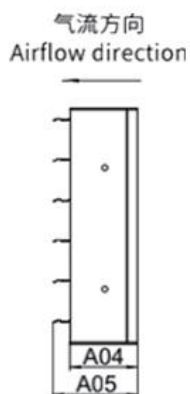
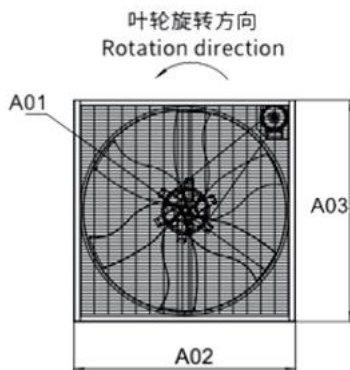

型号 Model No.		QT915B2-077-00		QT1270B2-081-00	
规格 Diameter of blade (inch)		36"		50"	
电机 Motor	电压 Voltage (V)	380	230	380	230
	频率 Hertz (Hz)	50	60	50	60
	相数 Phase	3		3	
	功率 Power (KW)	0.55		1.1	
	输入电流 Current @0Pa (A)	1.7		3	
性能参数 Performance	风量 Airflow (m ³ /hr.)	0pa	18400	38700	
		-25pa	16080	35500	
		-50pa	12750	30500	
	能效比 Efficiency (CMH/Watt)	23.3		21.8	
特征 Features	驱动方式 Drive	皮带传动 Belt driven			
	风叶 Propeller	6片铝叶 6-Aluminum			
外形尺寸 Dimension (mm)	A01	915		1270	
	A02	1000		1380	
	A03	1000		1380	
	A04	450		450	
	A05	500		500	
	洞口尺寸 Dimension of opening (mm)	1020×1020		1440×1440	



BL系列 | BL SERIES

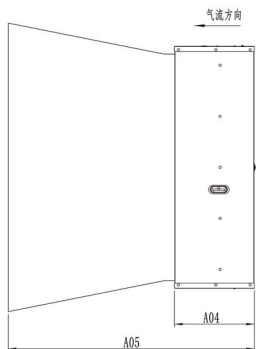
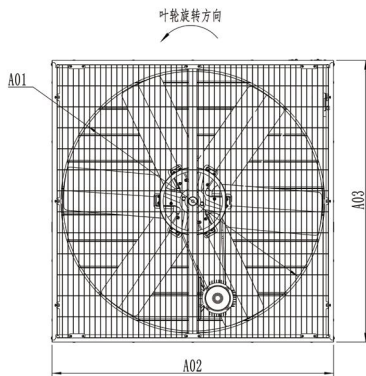
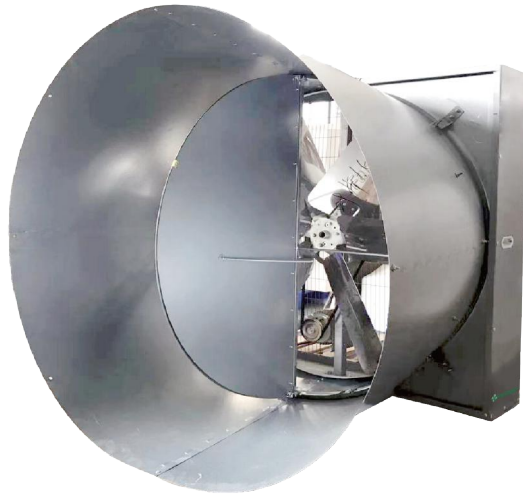

型号 Model No.		BL915B2-077-00	BL1270B2-081-00	
规格 Diameter of blade (inch)		36"	50"	
电机 Motor	电压 Voltage (V)	380	380	
	频率 Hertz (Hz)	50	50	
	相数 Phase	3	3	
	功率 Power (KW)	0.55	1.1	
	输入电流 Current @0Pa (A)	1.5	3.2	
性能参数 Performance	风量 Airflow (m ³ /hr.)	0pa	20483	44084
		-25pa	17616	40125
		-50pa	14570	34561
	能效比 Efficiency (CMH/Watt)	26.3	26.5	
特征 Features	驱动方式 Drive	皮带传动 Belt driven		
	风叶 Propeller	6片铝叶 6-Aluminum		
外形尺寸 Dimension (mm)	A01	915	1270	
	A02	1000	1380	
	A03	1000	1380	
	A04	300	300	
	A05	1180	1300	
	洞口尺寸 Dimension of opening (mm)	1020×1020	1400×1400	



BG系列 | BG SERIES

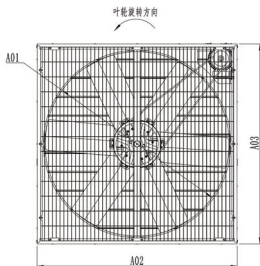
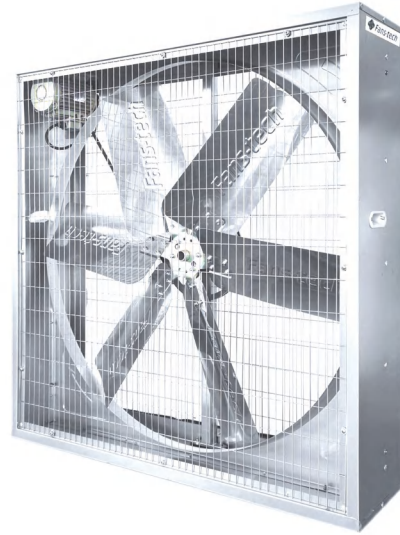
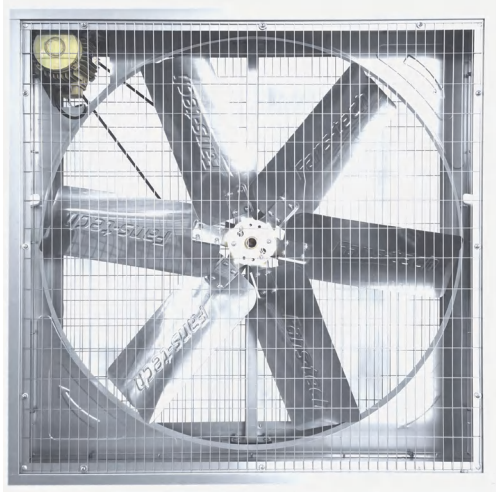

型号 Model No.		BG-900B2-077-00	BG-1270B2-081-00
规格 Diameter of blade (inch)		36"	50"
电机 Motor	电压 Voltage (V)	380	380
	频率 Hertz (Hz)	50	50
	相数 Phase	3	3
	功率 Power (KW)	0.55	1.1
	输入电流 Current @0Pa (A)	1.5	3.2
性能参数 Performance	风量 Airflow (m ³ /hr.)	20000	42000
特征 Features	驱动方式 Drive	皮带传动 Belt driven	
	风叶 Propeller	6片铝叶 6-Aluminum	
外形尺寸 Dimension (mm)	A01	915	1270
	A02	1000	1380
	A03	1000	1380
	A04	330	330

循环风机系列

Circulation Fan Series





YNF系列特点与优势

Features & Aavantages

 **降温快**
高强度铝合金扇叶，叶型采用流体仿真最优化设计，风机两侧风量损失小，风量大，降温迅速，快速优化养殖舍内空气质量。

 **覆盖面广**
采用可调节角度的导流板，无需改变风机吊装位置，只需简单操作即可实现距离远、覆盖面广的送风。

 **易维护**
采用进口皮带，皮带配有自动张紧器，可延长调试周期；如需替换皮带也无需拆下叶轮，易于维护。

 **超省电**
采用超高效电机，实现高能效比，低功耗，节能省电，节约养殖成本，提高养殖收益。

 **耐腐蚀**
壳体由高密度玻璃钢材料制成，强度高而轻便，且耐腐蚀能力超强。

 **体感舒适**
整机低速运转，运行安静，风量大而均匀、柔和，让动物倍感舒适。

 **个性化**
可选配变频器，实现风机的无极调速。

 **应用场景**
多用于牛舍等做空气循环，通风降温，干燥畜床等之用。也可适配雾化器，实现加湿与抑制粉尘的作用。

 **Fast cooling**
Being optimized with fluid simulation design, high-strength aluminum alloy propeller provides large air flow with few air volume loss on both sides, which enables fast cooling and quickly air quality improving in cowsheds.

 **Wide airflow**
Long air blow distance and wide air supply area can be simply achieved by adjusting the airfoil deflectors instead of changing the original position of the fan.

 **Easy to maintain**
An automatic belt tensioner is adopted to extend debugging period; and the belt change is easily done without removing the propeller.

 **Power saving**
The use of ultra-efficient motor achieves high energy efficiency ratio to reduce power consumption and costs.

 **Anti-corrosion**
Corrosion resistance high-density fiberglass housing, with high strength and light weight.

 **Animal comfort**
Silently supply gentle wind at low operation speed to comfort the animals.

 **Customized choise**
Optional frequency converter to realize the stepless speed regulation of the fan.

 **Application**
Widely used in cowsheds and stables for air circulation, cooling, and livestock beds drying; an atomizer can be fitted with to achieve the effects of humidification and suppression of dust.





YNF系列 | YNF SERIES

YNF55"





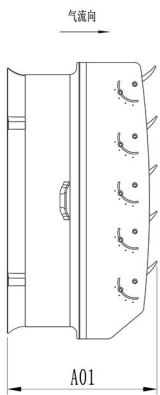
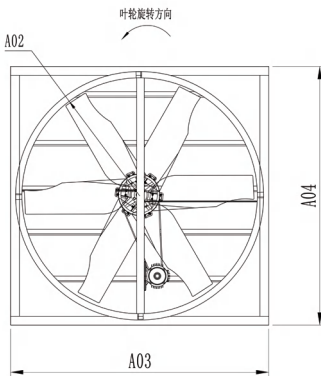



YNF72"









型号 Model No.		YNF1400B2-081-00		YNF1830B2-106-00	
规格 Diameter of blade (inch)		55"		72"	
电机 Motor	电压 Voltage (V)	380	230	380	230
	频率 Hertz (Hz)	50	60	50	60
	相数 Phase	3		3	
	功率 Power (KW)	1.1		2.2	
输入电流 Current @0Pa (A)		3.1		4.6	
性能参数 Performance	风量 Airflow (m ³ /hr.)	45000		85200	
	风量 Airflow (CFM)	26500		50180	
	能效比 Efficiency (m ³ /hr./W)	36		39.6	
	能效比 Efficiency (cfm/Watt)	21.2		23.3	
特征 Features	驱动方式 Drive	皮带传动 Belt driven			
	皮带 Belt	日本三星带自动张紧器 Mitsuboshi with automatic tensioner			
	风叶 Propeller	6片铝叶 6-Aluminum			
	导流板 Deflector	4		5	
外形尺寸 Dimension (mm)	A01	740		1100	
	A02	1400		1830	
	A03	1600		2050	
	A04	1600		2050	

YNF900系列特点与优势

Features & Aavantages

-  **降温快**
 高强度压铸铝扇叶，叶型采用流体仿真最优化设计，风量大，降温迅速，快速优化养殖舍内空气质量。
-  **低噪音**
 高强度压铸铝扇叶，叶型采用流体仿真最优化设计，风量大，降温迅速，快速优化养殖舍内空气质量。
-  **免维护**
 全系列均采用直联驱动，传动效率高，结构简单，免除定期更换皮带的麻烦，减少更换皮带的成本。
-  **超省电**
 采用超高效电机，实现高能效比，低功耗，节省省电，节约养殖成本，提高养殖收益。
-  **高防腐**
 钢质喷粉机身与防护网罩，SUS304不锈钢材质紧固件与配附件，为风机提供卓越的耐腐蚀能力，坚固耐用。
-  **超耐用**
 机身采用2.0mm厚钢板制成，坚固耐用。

-  **Fast cooling**
 Being optimized with fluid simulation design, high-strength die-cast aluminum airfoil propeller provides large air flow, which enables fast cooling and quickly air quality improving in cowsheds.
-  **Low Noise**
 The smooth propeller shape and high dynamic balance accuracy makes tiny friction coefficient between the blade and air combined with small resonance during running, which ensures low noise and improves the living comfort for the animals.
-  **Maintenance Free**
 Direct driving with high transmission efficiency and simple structure, which eliminates the trouble of regular belt replacement and reduces the using cost.
-  **Power saving**
 The use of ultra-efficient motor achieves high energy efficiency ratio to reduce power consumption and costs.
-  **Anti-corrosion**
 The powder-sprayed steel body and protective mesh, combined with SUS304 stainless steel accessories provide excellent corrosion resistance
-  **High durability**
 2.0mm thickness steel fan body with epoxy resin coating, sturdy and durable.





YNF900系列 | YNF900 SERIES

5叶



YNF900B3-077-00

3叶



YNF900B4-077-00

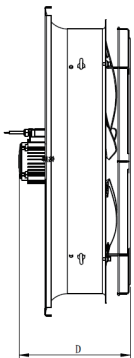
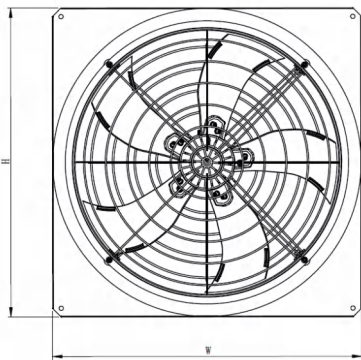

型号 Model No.		YNF900B3-077-00	YNF900B4-077-00
规格 Diameter of blade (inch)		36"	36"
电机 Motor	电压 Voltage (V)	380	380
	频率 Hertz (Hz)	50	50
	相数 Phase	3	3
	功率 Power (KW)	0.75	0.37
性能参数 Performance	转速 Speed (rpm)	930	730
	风量 Airflow (m ³ /hr.)	24500	16500
	风量 Airflow (CFM)	14430	9720
	能效比 Efficiency (m ³ /hr/W)	25.8	33
	能效比 Efficiency (cfm/Watt)	15.2	19.4
特征 Features	驱动方式 Drive	直联驱动 Direct drive	
	风叶 Propeller	5片铝叶 5-Aluminum	3片铝叶 3-Aluminum
外形尺寸 Dimension (mm)	宽×深×高 W×D×H	1070×380×1070	1070×380×1070

屋顶风机系列

Chimney Fan Series

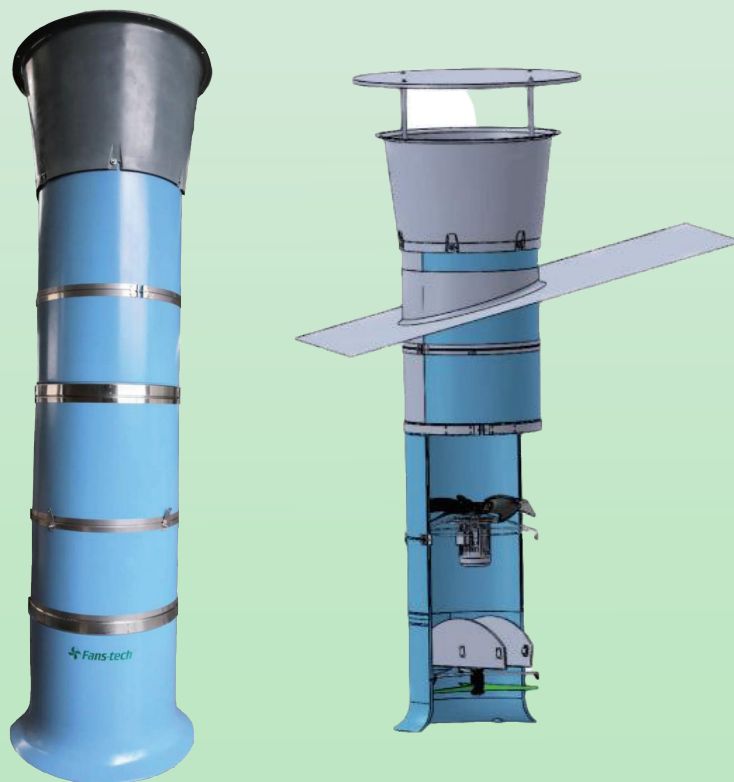



屋顶风机系列特点与优势

Features & Advantages

 **风量大**
高强度机翼型压铸铝扇叶，采用流体仿真最优化设计叶型，确保养殖舍内充足的空气流通量。

 **噪音低**
流畅的叶型与高动平衡精度使运行中的叶片与空气摩擦系数小、共振小、确保低噪音，提升动物生存环境的舒适度。

 **免维护**
全系列均采用直联驱动，传动效率高，结构简单，免除定期更换皮带的麻烦，减少更换皮带的成本。

 **高效节能**
超高效变频电机，IP55防水防尘保护，F级绝缘，可使风机在5Hz至50Hz范围内稳定运行，从而实现风量从0到最大任意调节输出，满足不同季节通风需求，节能省电。

 **抗冷凝**
管道采用聚氨酯材料，外涂防腐及抗紫外线涂层，保温，抗冷凝。是高纬度寒带地区使用的不二之选。

 **自由送风角度**
采用进口风阀控制器，双叶风阀角度可在0到90度范围内稳定调节。

 **Large Air Flow**
Being optimized with fluid simulation design, the high-strength die-cast airfoil aluminum propeller provides large air flow to ensure adequate air circulation in the breeding house.

 **Low Noise**
The smooth propeller shape and high dynamic balance accuracy makes tiny friction coefficient between the blade and air combined with small resonance during running, which ensures low noise and improves the living comfort for the animals.

 **Maintenance Free**
Direct driving with high transmission efficiency and simple structure eliminates the trouble of regular belt replacement and reduces the using cost.

 **Energy-efficient**
IP55 waterproof and dust-proof protection, F class insulation, ultra-efficient variable frequency motor enables the fan to operate stably in the range of 5Hz to 50Hz, so as to achieve any adjustable output of air volume from 0 to the maximum.

 **Anti-condensation**
Exhaust air pipe made of high-density polyurethane foam with anti-corrosion and anti-UV coating outside, heat preservation, and anti-condensation, withstand climatic extremes and solar radiation. The best choice for use in high latitude cold regions.

 **Free air supply angle**
Adopting imported damper controller, the double-door damper angle is adjustable within the range of 0 to 90 degree.



GF系列 | GF SERIES

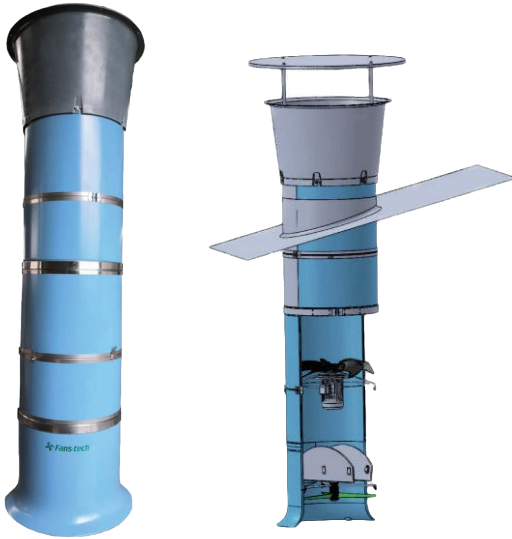

ADVANTAGES

- ▶ 支持485总线实现多台风机的集中运行控制(选配);
- ▶ 适用于欧式垂直通风模式, 可实现更加精准的养殖舍通风控制。
- ▶ Support centralized operation control of multiple fans (Optional);
- ▶ It is suitable for vertical ventilation mode to realize more precise ventilation control of breeding house.

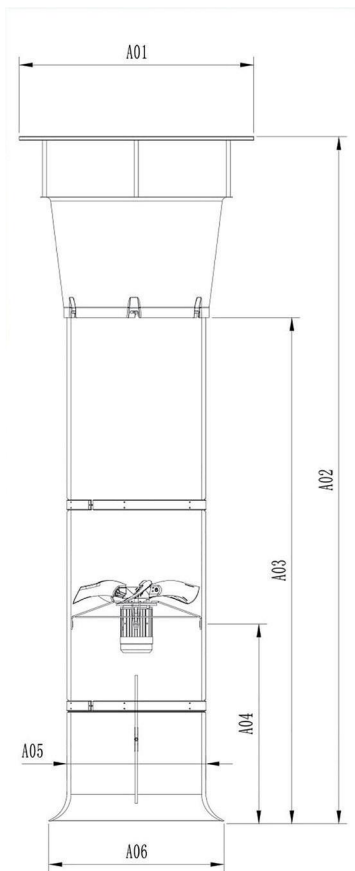

型号 Model No.		GF625V3-077-00	GF915V3-081-00	
规格 Diameter of blade (inch)		24"	36"	
电机 Motor	电压 Voltage (V)	380	380	
	频率 Hertz (Hz)	50	50	
	相数 Phase	3	3	
	功率 Power (KW)	0.37	0.75	
输入电流 Current @0Pa (A)		1.2	2.2	
性能参数 Performance	风量 Airflow (m ³ /hr.)	0pa	14100	25100
		-40pa	11300	22400
		-60pa	9300	20300
能效比 Efficiency (CMH/Watt)		31.5	27	
特征 Features	驱动方式 Drive	直联驱动 Direct drive		
	风叶 Propeller	5片铝叶 5-Aluminum		
	轴承 Bearing	NSK		
外形尺寸 Dimension (mm)	A01	Φ1160	Φ1453	
	A02	Φ3420	Φ3922	
	A03	Φ2520	Φ2822	
	A04	Φ995	Φ1295	
	A05	Φ688	Φ980	
	A06	Φ868	Φ1160	
洞口尺寸 Dimension of opening (mm)		Φ730	Φ1020	

圆筒风机系列

Drum Fan Series



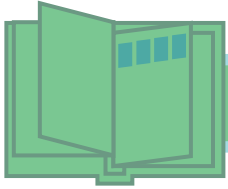

TF 系列 | TF SERIES

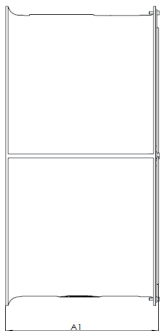
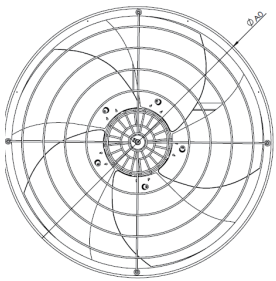

型号 Model No.		TF350A2-058-00	TF450A2-058-00	TF500A2-070-00	TF710B3-081-00	
规格 Diameter of blade (inch)		14"	18"	20"	28"	
电机 Motor	电压 Voltage (V)	220	220	220	380	
	频率 Hertz (Hz)	50	50	50	50	
	相数 Phase	3	3	3	3	
	功率 Power (KW)	0.12	0.18	0.37	0.75	
	输入电流 Current @0Pa (A)	0.5	1.0	1.6	2.5	
性能参数 Performance	风量 Airflow (m ³ /hr.)	0pa	2800	4700	7050	16380
		50pa	2000	4000	6000	15000
		100pa	/	2840	4830	13080
特征 Features	驱动方式 Drive	直联驱动 Direct drive				
	风叶 Propeller	5片铝叶 5-Aluminum				
外形尺寸 Dimension (mm)	A01	400	500	550	760	
	A02	300	350	350	400	

玻璃钢圆筒风机系列特点与优势

Features & Advantages

- ▶ **大风量**
采用流体仿真最优化设计，性能佳，风量大，确保使用空间内充足的空气流量；
- ▶ **低噪音**
高强度尼龙扇叶，运行负载低，抗变形，叶型流畅，确保低噪音，提升动物生存环境的舒适度；
- ▶ **免维护**
全系列均采用直联驱动，传动效率高，结构简单，免除定期更换皮带的麻烦，减少更换皮带的成本。
- ▶ **超高效**
采用超高效电机，IP55防水防尘保护，F级绝缘，效率高达85%，节能省电，节约养殖成本，提高养殖收益；
- ▶ **强度高**
采用高分子聚合玻璃钢壳体，重量轻，防腐蚀，强度高；
- ▶ **寿命长**
喷粉金属支架，结构强度高，防锈能力佳，使用寿命长。
- ▶ **Large airflow**
Being optimized with fluid simulation design, excellent performance and large air flow to ensure adequate air circulation;
- ▶ **Low noise**
High-strength nylon propeller with anti-deformation, smooth blade shape and low operating load, which ensures low noise and help to improve the comfort of animals' living environment;
- ▶ **Maintenance-free**
Direct driving with high transmission efficiency and simple structure eliminates the trouble of regular belt replacement and reduces the using cost;
- ▶ **Ultra-efficient motor**
IP55 waterproof and dust-proof protection, F class insulation, ultra-efficient motor with 85% efficiency enables animal producers to save breeding costs and increase profits;
- ▶ **Anti-corrosion**
High molecular polymer fiberglass reinforced shell with light weight, anti-corrosion and good strength;
- ▶ **Long service life**
Powder-sprayed metal bracket provides good structural strength, terrific anti-rust ability and long service life.

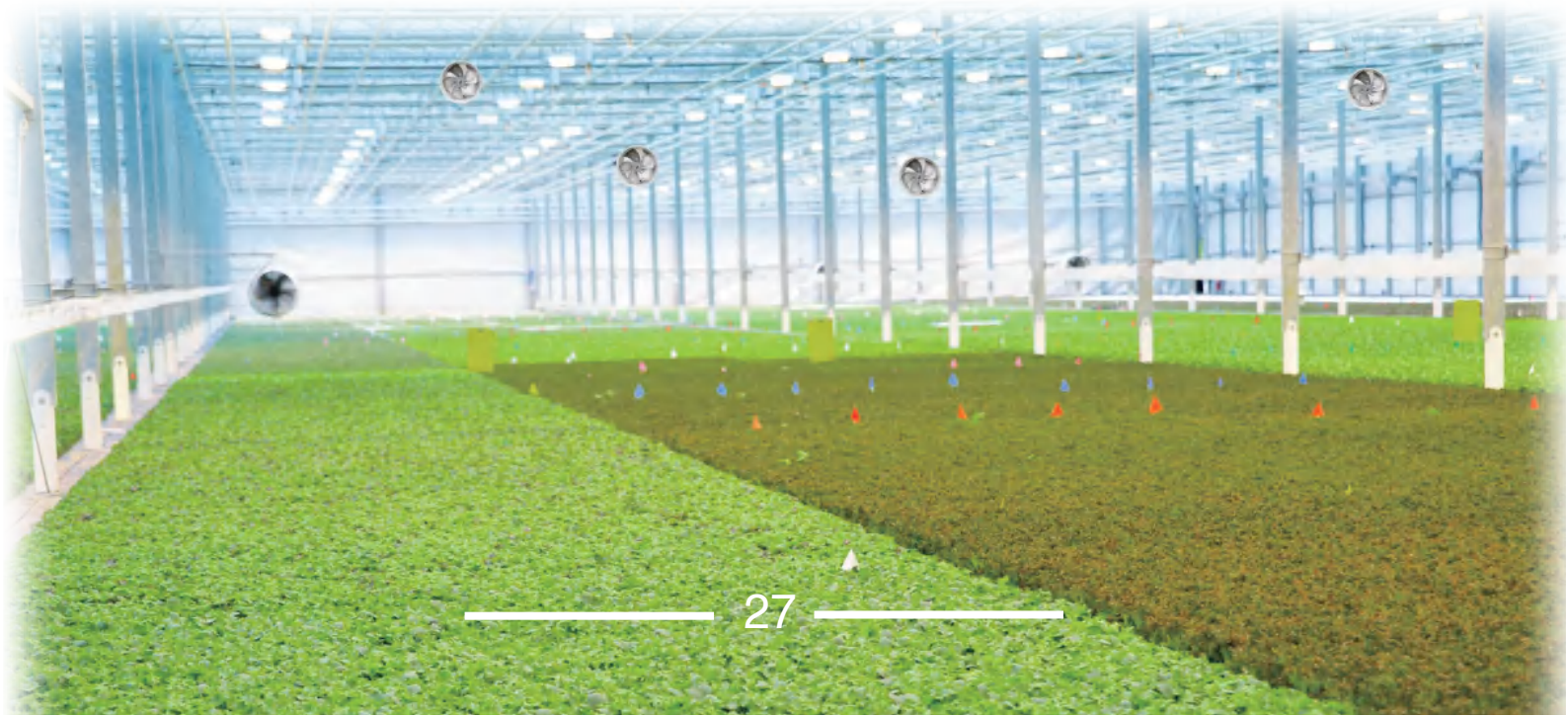

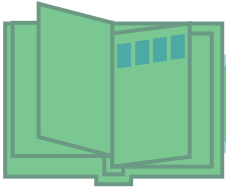

TF600 系列 | TF600 SERIES



600 mm (24")

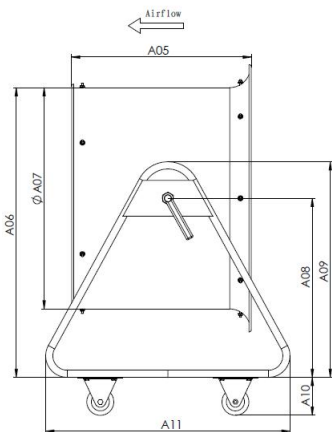
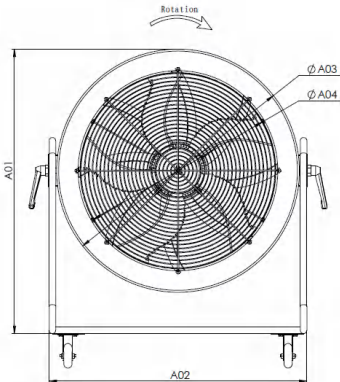

规格 Diameter of blade (inch)		24"						
电机 Motor	电压 Voltage (V)	3~380	3~200					
	频率 Hertz (Hz)	50~60	50~60					
	相数 Phase	4						
	功率 Power (KW)	1.5						
	输入电流 Current @OPa (A)	6						
性能参数 Performance	风量 Airflow (m ³ /hr.)	18000						
	风量 Airflow (CFM)	10590						
特征 Features	驱动方式 Drive	直联驱动						
	风叶 Propeller	7片机翼型铝叶 7 Aluminium airfoil blades						
	轴承 Bearing	NSK轴承						
外形尺寸 Dimension (mm)	A01	A02	A03	A04	870	790	744	600
	A05	A06	A07	A08	500	806	616	498
	A09	A10	A11		600	106	680	

移动式轴流风机系列特点与优势

Features & Aavantages

【产品优势】

- ★ 风量高达18000M³/H;
- ★ 送风距离长达30米，大范围送风;
- ★ 风向俯仰角度90°可调节;
- ★ 带刹车脚轮，移动便捷;
- ★ 可加配雾化装置，带雾距离长达30米，大范围加湿。

【用途】

- 🏠 畜牧养殖通风、降温;
- 🏭 大型工厂降温、换气;
- 🏟️ 体育馆、大型活动举办等户外场所通风、降温;
- 🏗️ 建筑工地等户外施工场所通风、降温、粉尘压制。

【Features】

- ★ Air flow up to 18000M³/H;
- ★ Air supply distance up to 30M, with large fresh air coverage;
- ★ Adjustable blowing direction between 0~90°;
- ★ With brake casters, easy to move;
- ★ Misting device is available to be equipped, misting distance is up to 30M, large range of humidification.

【Application】

- 🏠 Ventilation and cooling for animal husbandry;
- 🏭 Cooling and circulation in factories;
- 🏟️ Cooling and humidification in public places such as gymnasiums and large-scale events;
- 🏗️ Ventilation, cooling and dust suppression in outdoor construction sites.

配件系列

Accessories

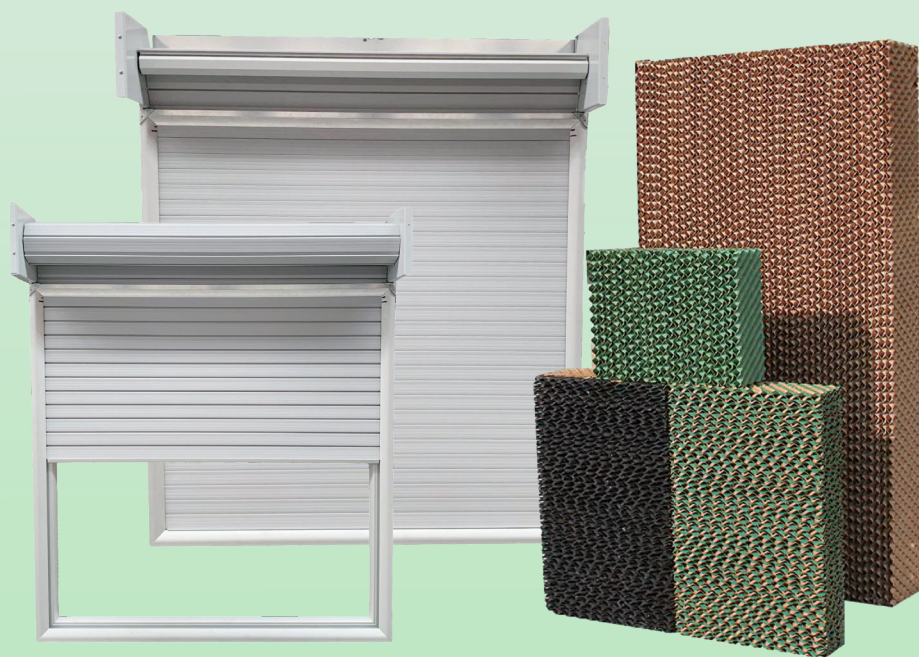

电动卷帘门 | Electric rolling door



电机到达定位后断电自锁
When reaches the positioning,
the motor power is cut off and self-locking

电机参数 Motor data	电压 Volts (V)	220
	频率 Hertz (HZ)	50
	额定电流 Rated current (A)	0.89
	功率 Power (W)	205
	运行耗时 Operation time consuming (S)	全开 Full open
全闭 Full closed		19
特征 Features	框架 Frame	铝合金 Aluminium alloy
	卷帘片 Shutter piece	PVC
	支架 Bracket	钢板喷粉 Coated steel
外形尺寸 Overall dimensions (mm)	1490*1715*255	
洞口尺寸 Opening dimensions (mm)	1270*1270	

电动卷帘门特点与优势

Features & Aavantages

- ▶ 通过严苛的烟雾试验，确保关闭状态时超强的密闭性；
- ▶ 可与风机电机联动，全开状态下实现零风阻运行；
- ▶ 抗压能力强，可长期承载高负压风机强风运行而不变形；
- ▶ 高强度塑料联片、铝合金机身，抗腐蚀，适用于各种严苛的养殖环境，或海上环境应用。
- ▶ Its air tightness passed rigorous smoke isolation test in the close state;
- ▶ It can be linked with the fan motor to realize zero wind resistance operation in the fully open state ;
- ▶ Strong pressure resistance, can long-term bear strong wind making by high negative pressure fan without deformation;
- ▶ High-strength plastic coupling and aluminum alloy body, with anti-corrosion to be adapted to all kinds of harsh animal husbandry environment, or marine environment.

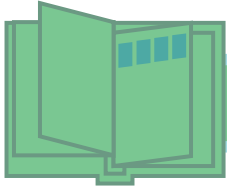

高强度水帘 | COOLING PAD

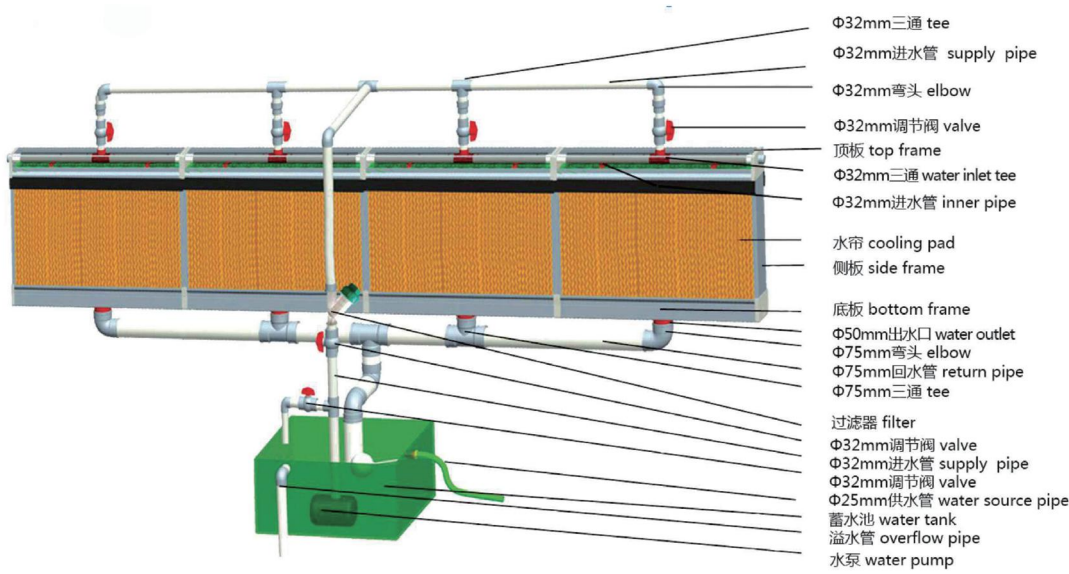

不锈钢外框
Stainless Steel Frame



铝合金外框
Aluminum Alloy Frame

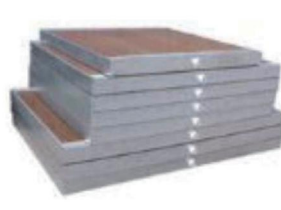

镀锌板外框
Galvanized Frame



湿帘专用过滤器
Filter

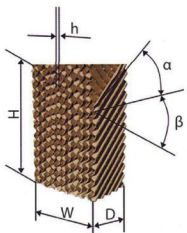

型号 Model	H (mm)	W (mm)	D (mm)	h (mm)	α ($^{\circ}$)	β ($^{\circ}$)
7060型	1000-2500	200-800	100-200	7	45	45
7090型	1000-2500	200-800	100-200	5	45	45

高强度水帘特点与优势

Features & Advantages

- ▶ 寿命长
波纹纸特殊处理，结构强度高，耐腐蚀，使用周期长；
- ▶ 渗透均匀
具有优良的渗透吸水性，可以保证水均匀淋透整个湿帘墙；
- ▶ 蒸发面积大
特定的立体空间结构，为水与空气的热交换提供了最大的蒸发面积；
- ▶ 个性化
外框有铝合金与镀锌板可选；
- ▶ 成本效率高
“湿帘-风机”的纵向通风降温组合是经济、有效的温室夏季降温措施。季降温措施。

- ▶ Long Durability
The corrugated paper is specially treated with high structural strength, corrosion resistance and long service life.
- ▶ Uniform permeability
Excellent water permeability and absorption of the corrugated paper ensures the water evenly penetrates the entire cooling pad wall.
- ▶ Large evaporation area
The specific three-dimensional space structure provides the largest evaporation area for the heat exchange between water and air.
- ▶ Customer-oriented Option
Aluminum alloy and galvanized steel are available for the side frame.
- ▶ Cost effective
The "cooling pad & fan" longitudinal ventilation and cooling combination is an economical and effective summer cooling measure for farm buildings.

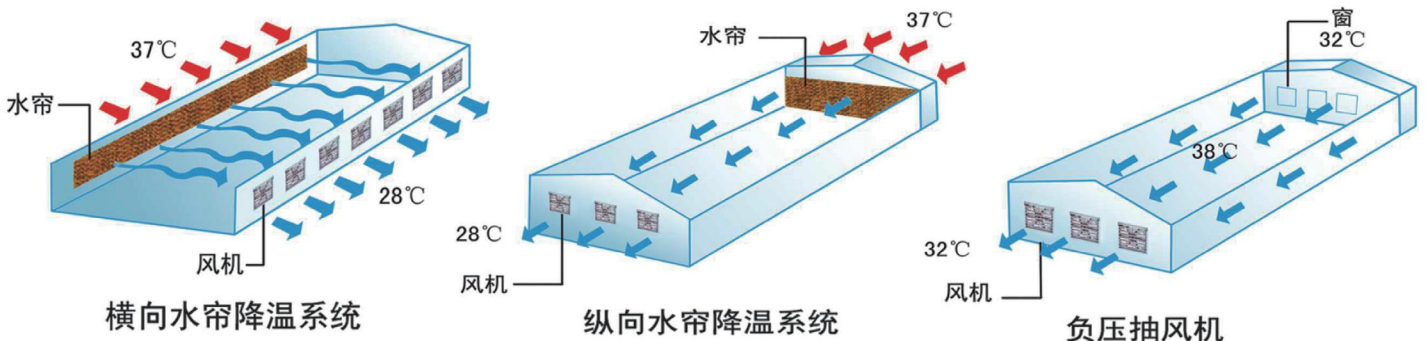



广东泛仕达农牧风机有限公司
Guangdong Fans-tech Agro Co., Ltd



| www.fanstech-agro.com



| 广东省云浮市新兴县新城镇新成工业园二环路西段32号

No.32, West Erhuan Road, Xincheng Industrial Park, Xincheng Town, Xinxing, Guangdong, China

国内销售部 Domestic Sales Department



| 0766-2929903



| tech097@fans-tech.com

海外销售部 Overseas Sales Department



| +86-766-2500860



| tech097@fans-tech.com / viola@fans-tech.com